

# IL6-P3 LED 8" and 12" Traffic Signal Module 10-28Vdc Incandescent Look Arrow

**Leading the LED Industry Since 1992**  
With over 7,000,000 units installed globally

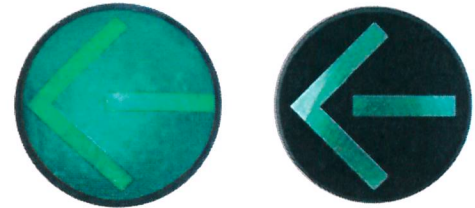

## Superior Performance and Reliability





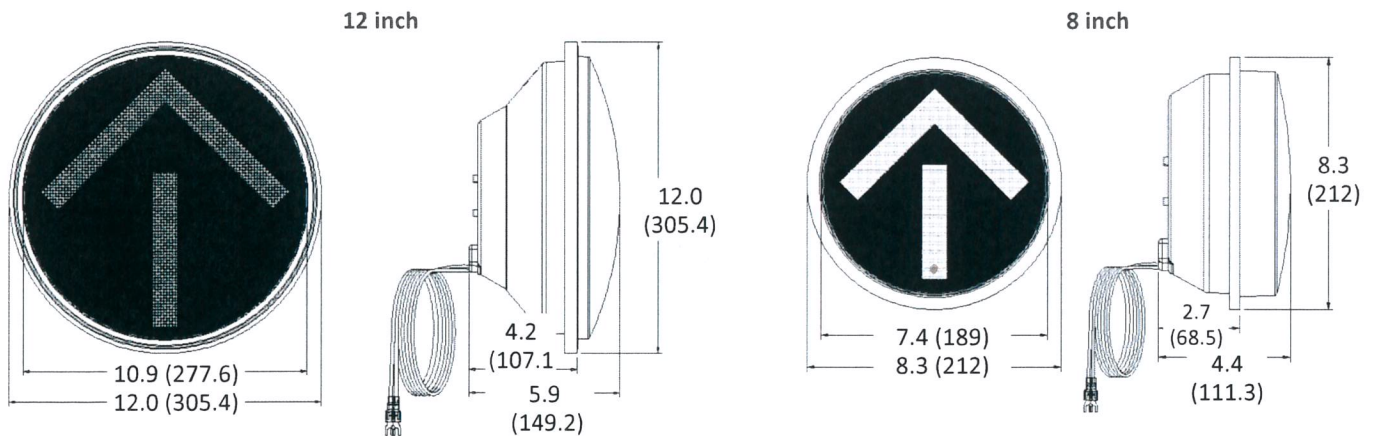

- Easy installation into existing signal housings
- Patented innovative optical technology
- Wider viewing angle and enhanced uniformity
- Maintains 70% of the initial lumen intensity after 100,000 hours of operation
- Overmolded electrical connectors provide fully-weatherized seal
- Excellent moisture and dust resistance
- Utilizes constant current source to maintain consistent light output
- Superior thermal management
- Energy efficient and environmentally friendly
- 5-year limited warranty

## Mechanical Dimensions [in(mm)]



### Model Specifications and Ordering Options

Operating Temperature: -40°F to 165°F (-40°C to 74°C)	Turn-On/Turn-Off Time: < 75msec
Operating Voltage: 10-28Vdc	Turn-Off Voltage: > 35Vac

	Model Number and Color	Wattage Drawn	Voltage	Dominant Wavelength	Maintained Intensity (cd) Min.
<b>IL6-P3</b>	<b>8 inch arrow</b>				
	TSL-08RA-IL6-B1-P3 	2.4	10-28Vdc	626	N/A
	TSL-08YA-IL6-B1-P3 	4.3	10-28Vdc	589	N/A
	TSL-08GA-IL6-B1-P3 	2.2	10-28Vdc	500	N/A
	<b>12 inch arrow</b>				
	TSL-12RA-IL6-B1-P3 	3	10-28Vdc	626	58.4
	TSL-12YA-IL6-B1-P3 	8	10-28Vdc	589	145.6
TSL-12GA-IL6-B1-P3 	3.7	10-28Vdc	500	76.0	

Please note: Tinted lens standard, clear lens optional. When ordering clear lens, please add "-CLR" to model number

### Standard Conformance

- MIL-STD-810F Moisture Resistant
- MIL-STD-883 Mechanical Vibration

### ITE VTCSH Compliance - LED Arrow Signal Supplement – July 1, 2007

• Conditioning	ITE 6.4.2	• Luminous Intensity	ITE 6.4.4.1-4
• Mechanical Vibration	ITE 6.4.3.1	• Chromaticity	ITE 6.4.4.6
• Temperature Cycling	ITE 6.4.3.2	• Current Consumption	ITE 6.4.6.1